

# 1260 VXI SWITCHING CARD 20 CHANNEL PLUG-IN

## MODEL 1260-X121

PUBLICATION NO. 980914-X121

### RACAL INSTRUMENTS

#### United States

(Corporate Headquarters and Service Center)  
4 Goodyear Street, Irvine, CA 92618  
Tel: (800) 722-2528, (949) 859-8999; Fax: (949) 859-7139

5730 Northwest Parkway Suite 700, San Antonio, TX 78249  
Tel: (210) 699-6799; Fax: (210) 699-8857

#### Europe

(European Headquarters and Service Center)  
18 Avenue Dutartre, 78150 LeChesnay, France  
Tel: +33 (0)1 39 23 22 22; Fax: +33 (0)1 39 23 22 25

29-31 Cobham Road, Wimborne, Dorset BH21 7PF, United Kingdom  
Tel: +44 (0) 1202 872800; Fax: +44 (0) 1202 870810

Via Milazzo 25, 20092 Cinisello B, Milan, Italy  
Tel: +39 (0)2 6123 901; Fax: +39 (0)2 6129 3606

Racal Instruments Group Limited, Technologie Park, D-51429 Bergisch Gladbach, Germany  
Tel: +49 2204 844205; Fax: +49 2204 844219

[info@racalinstruments.com](mailto:info@racalinstruments.com)

[sales@racalinstruments.com](mailto:sales@racalinstruments.com)

[helpdesk@racalinstruments.com](mailto:helpdesk@racalinstruments.com)

<http://www.racalinstruments.com>

[info@racalinstruments.de](mailto:info@racalinstruments.de)

[www.racalinstruments.de](http://www.racalinstruments.de)



---

**PUBLICATION DATE: October 21, 2005**

Copyright 2005 by Racal Instruments, Inc. Printed in the United States of America. All rights reserved.  
This book or parts thereof may not be reproduced in any form without written permission of the publisher.

---

---

## THANK YOU FOR PURCHASING THIS RACAL INSTRUMENTS PRODUCT.

---

---

For this product, or any other Racal Instruments product that incorporates software drivers, you may access our web site to verify and/or download the latest driver versions. The web address for driver downloads is:

<http://www.racalstruments.com/downloads>

If you have any questions about software driver downloads or our privacy policy, please contact us at

[info@racalstruments.com](mailto:info@racalstruments.com)

---

---

## WARRANTY STATEMENT

---

---

All Racal Instruments, Inc. products are designed and manufactured to exacting standards and in full conformance to Racal's ISO 9001:2000 processes.

This warranty does not apply to defects resulting from any modification(s) of any product or part without Racal Instruments express written consent, or misuse of any product or part. The warranty also does not apply to fuses, software, non-rechargeable batteries, damage from battery leakage, or problems arising from normal wear, such as mechanical relay life, or failure to follow instructions.

This warranty is in lieu of all other warranties, expressed or implied, including any implied warranty of merchantability or fitness for a particular use. The remedies provided herein are buyer's sole and exclusive remedies.

For the specific terms of your standard warranty, or optional extended warranty or service agreement, contact your Racal customer service advisor. Please have the following information available to facilitate service.

1. Product serial number
2. Product model number
3. Your company and contact information

You may contact your customer service advisor by:

E-Mail:	<a href="mailto:Helpdesk@racalstruments.com">Helpdesk@racalstruments.com</a>	
Telephone:	+1 800 722 3262	(USA)
	+44(0) 8706 080134	(UK)
Fax:	+1 949 859 7309	(USA)
	+44(0) 1628 662017	(UK)

---

---

## RETURN of PRODUCT

---

---

Authorization is required from Racal Instruments before you send us your product for service or calibration. Call your nearest Racal Instruments support facility. A list is located on the last page of this manual. If you are unsure where to call, contact Racal Instruments, Inc. Customer Support Department in Irvine, California, USA at 1-800-722-3262 or 1-949-859-8999 or via fax at 1-949-859-7139. We can be reached at: [helpdesk@racalstruments.com](mailto:helpdesk@racalstruments.com).

---

---

## PROPRIETARY NOTICE

---

---

This document and the technical data herein disclosed, are proprietary to Racal Instruments, and shall not, without express written permission of Racal Instruments, be used, in whole or in part to solicit quotations from a competitive source or used for manufacture by anyone other than Racal Instruments. The information herein has been developed at private expense, and may only be used for operation and maintenance reference purposes or for purposes of engineering evaluation and incorporation into technical specifications and other documents which specify procurement of products from Racal Instruments.

---

---

## DISCLAIMER

---

---

Buyer acknowledges and agrees that it is responsible for the operation of the goods purchased and should ensure that they are used properly and in accordance with this handbook and any other instructions provided by Seller. Racal Instruments products are not specifically designed, manufactured or intended to be used as parts, assemblies or components in planning, construction, maintenance or operation of a nuclear facility, or in life support or safety critical applications in which the failure of the Racal Instruments product could create a situation where personal injury or death could occur. Should Buyer purchase Racal Instruments product for such unintended application, Buyer shall indemnify and hold Racal Instruments, its officers, employees, subsidiaries, affiliates and distributors harmless against all claims arising out of a claim for personal injury or death associated with such unintended use.

---

# FOR YOUR SAFETY

---

Before undertaking any troubleshooting, maintenance or exploratory procedure, read carefully the **WARNINGS** and **CAUTION** notices.



**CAUTION**  
RISK OF ELECTRICAL SHOCK  
DO NOT OPEN



This equipment contains voltage hazardous to human life and safety, and is capable of inflicting personal injury.



If this instrument is to be powered from the AC line (mains) through an autotransformer, ensure the common connector is connected to the neutral (earth pole) of the power supply.



Before operating the unit, ensure the conductor (green wire) is connected to the ground (earth) conductor of the power outlet. Do not use a two-conductor extension cord or a three-prong/two-prong adapter. This will defeat the protective feature of the third conductor in the power cord.



Maintenance and calibration procedures sometimes call for operation of the unit with power applied and protective covers removed. Read the procedures and heed warnings to avoid “live” circuit points.

Before operating this instrument:

1. Ensure the proper fuse is in place for the power source to operate.
2. Ensure all other devices connected to or in proximity to this instrument are properly grounded or connected to the protective third-wire earth ground.

If the instrument:

- fails to operate satisfactorily
- shows visible damage
- has been stored under unfavorable conditions
- has sustained stress

Do not operate until, performance is checked by qualified personnel.

## Table of Contents

Chapter 1 .....	1-1
SPECIFICATIONS .....	1-1
Introduction.....	1-1
Specifications .....	1-2
Power Dissipation.....	1-3
About MTBF .....	1-4
Ordering Information .....	1-5
Chapter 2 .....	2-1
INSTALLATION INSTRUCTIONS.....	2-1
Unpacking and Inspection .....	2-1
Reshipment Instructions.....	2-1
Installation .....	2-1
Module Configuration .....	2-2
Front Panel Connectors.....	2-3
Mating Connectors.....	2-6
More About Maximum Current Ratings.....	2-7
Installation .....	2-8

Chapter 3 .....	3-1
MODULE OPERATION .....	3-1
Operating Modes .....	3-1
Operating In Message-Based Mode.....	3-1
Channel Descriptors For The 1260-121 .....	3-1
Reply To The MOD:LIST? Command .....	3-2
Operating in Register-Based Mode .....	3-3
 Chapter 4 .....	 4-1
PRODUCT SUPPORT .....	4-1
Product Support .....	4-1
Reshipment Instructions.....	4-1
Support Offices .....	4-2
Repair and Calibration Request Form.....	4-3

**List of Figures**

Figure 1-1, The 1260-X121 .....1-1

Figure 2-1, 1260-X121 Block Diagram.....2-2

Figure 2-2, Front Panel Connector Pin Numbering.....2-3

**List of Tables**

Table 2-1, 1260-X121 Front-Panel Connections .....2-4

Table 2-2, Mating Connectors and Pins.....2-6

Table 3-1, Register Offset Addresses of the 1260-X121 Module .....3-4

Table 3-2, ID Register Functionality of the 1260-X121 Module .....3-4

Table 3-3, Register0 Functionality of the 1260-X121 Module.....3-5

Table 3-4, Register1 Functionality of the 1260-X121 Module.....3-5

Table 3-5, Register2 Functionality of the 1260-X121 Module.....3-5

Table 3-6, Register3 Functionality of the 1260-X121 Module.....3-6

Table 3-7, EPROM Descriptor Functionality of the 1260-X121 Module.....3-6

This page was left intentionally blank.



# Chapter 1

## SPECIFICATIONS

---

### Introduction

The 1260-X121 is a plug-in switch module developed for the Racal Instruments 1260-100X Adapt-a-Switch Carrier. The 1260-X121 includes the following features:

- Standard Adapt-a-Switch plug-in design, providing for ease of replacement
- Data-Driven embedded descriptor, allowing immediate use with any Option-01T switch controller, regardless of firmware revision level.

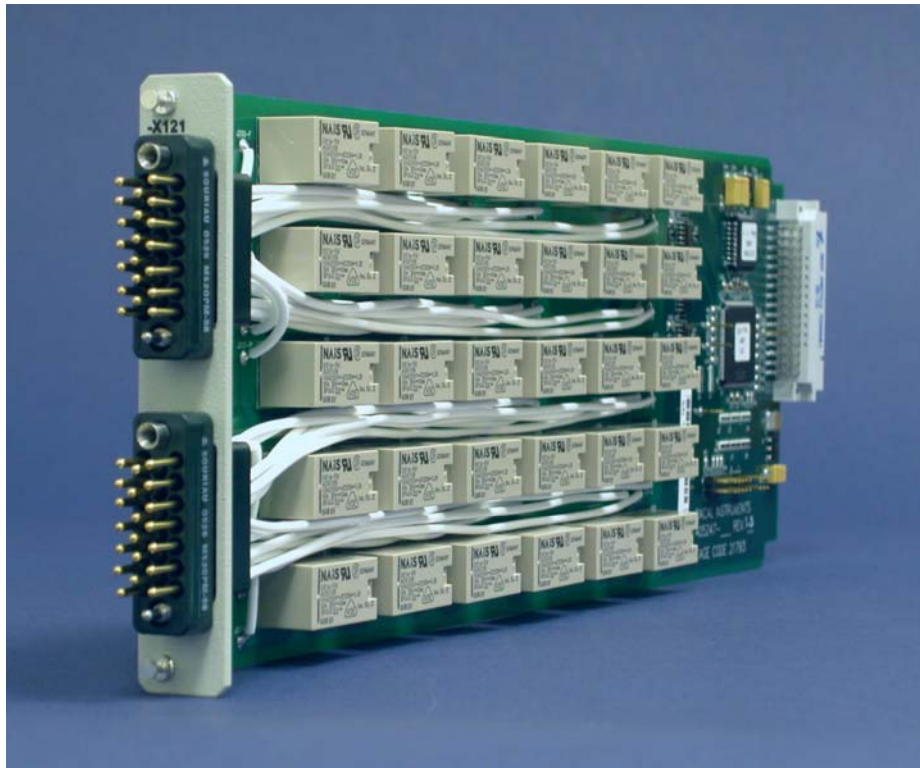

Figure 1-1, The 1260-X121

The 1260-X121 is a 20-channel single-wire switch consisting of 20 individual SPST relay switches and 10 1X2 switches by software configuration. The 1260-X121 plug-in fits into a 1260-100X Adapta-Switch Carrier.

## Specifications

Bandwidth (-3dB)	>300KHz
Insertion Loss	
300 KHz	< 2dB
Isolation	
DC to 100 KHz	> 60dB
100 to 300 KHz	> 50dB
Crosstalk	
DC to 100 KHz	< -60dB
100 to 300 KHz	< -50dB
Switching Voltage	
AC	440V, Max
DC	230V, Max
Switching Current	
AC	10A, Max.
DC	10A, Max
Switching Power	
AC	2500VA, Max
DC	300W, Max
Path resistance	< 100m $\Omega$
Capacitance	
Channel-Chassis	< 20pF
Open-Channel	< 20pF
Insulation resistance	> 10 <sup>9</sup> $\Omega$
Impulse Withstand Voltage	>1,000V
Relay Settling Time	< 15ms
Maximum Power Dissipation	60W
Cooling (25% Relays energized operating at full rated current)	4.27 Liters/sec @ 0.39 mmH <sub>2</sub> O

Shock	30g, 11ms, ½ sine wave
Vibration	0.013in. P-P, 5-55Hz
Bench Handling	4 in., 45°
Temperature	
Operating	0°C to +60°C
Non-operating	-40°C to +70°C
Relative Humidity	85% Max., non-condensing at < 30°C
Altitude	
Operating	15,000 feet
Non-operating	15,000 feet
Power Requirements	
+5VDC	300mA Max.
+5VDC	40mA per energized relay.
Weight	15.71oz. (0.445kg)
MTBF (MIL-HDBK-217-FN2 method)	
Including relays	783,549 hours at 25°C 718,344 hours at 30°C
Safety Standard	EN61010-1 Pollution Degree 2

## **Power Dissipation**

While the cooling of the Adapt-a-Switch carrier is dependent upon the chassis into which it is installed, the carrier can normally dissipate approximately 160 W. The maximum power dissipation for an individual module is 60W. Care must be taken, then, in the selection and loading of the plug-in modules used in the carrier. It is not possible to fully load the carrier, energize every relay, and run full power through every set of contacts, all at the same time. In practice this situation would never occur.

To properly evaluate the power dissipation of the plug-in modules, examine the path resistance, the current passing through the relay contacts, the ambient temperature, and the number of relays closed at any one time.

For example, if a 1260-X121 module (containing 20 relays) has 5 relays closed, passing a current of 10 A, then:

$$\text{Total power dissipation} = [(\text{current})^2 * (\text{path resistance}) * 5] + (\text{quiescent power})$$

By substituting the actual values:

$$\text{Total power dissipation} = [(10 \text{ A})^2 * (0.1 \Omega) * 5] + (1.5 \text{ W}) = 51.5 \text{ W at } 55^\circ\text{C}$$

This is acceptable power dissipation for an individual plug-in module. In practice, rarely are more than 25% of the module's relays energized simultaneously, and rarely is full rated current run through every path. In addition, the actual contact resistance is typically one-half to one-fourth the specified maximum, and temperatures are normally not at the rated maximum. The power dissipated by each plug-in should be no more than 15 W if all six slots are used simultaneously. This yields the following guideline:

3 A	Max. 15 relays closed
5 A	Max. 6 relays closed
10 A	Max. 2 relays closed

The numbers in the above table represent worst-case, elevated-temperature, end-of-life conditions.

Additionally, if fewer plug-in modules are used, more power may be dissipated by the remaining cards. By using a chassis with high cooling capacity, such as the Racal Instruments 1261B, almost any configuration may be realized.

## About MTBF

The 1260-X121 MTBF is 783,549 hours at 25°C and 718,344 hours at 30°C, calculated in accordance with MIL-HDBK-217E, with the electromechanical relays set at 50% rated load at 85°C. Factors affecting relay life expectancy are:

1. Switched voltage
2. Switched current
3. Switched power
4. Maximum switching capacity
5. Maximum rated carrying current
6. Load type (resistive, inductive, capacitive)
7. Switching repetition rate
8. Ambient temperature

The most important factor is the maximum switching capacity,

which is an interrelationship of maximum switching power, maximum switching voltage and maximum switching current. When a relay operates at a lower percentage of its maximum switching capacity, its life expectancy is longer. The maximum switching capacity specification is based on a resistive load, and must be further de-rated for inductive and capacitive loads.

The relay used on the 1260-X121 plug-in is Racal part no. 310344. The relay manufacturer's specifications for this relay are:

Life Expectancy	
Mechanical	10,000,000 operations
Electrical	100,000 operations at full rated load

For additional relay specifications, refer to the relay manufacturer's data sheet.

## Ordering Information

Listed below are part numbers for 1260-X121 switch module and available mating connector accessories. Each 1260-X121 uses two mating connectors.

ITEM	DESCRIPTION	PART #
1260-X121 Switch Module	1260-X121	408008
	Consists of:	
	PCB Assembly	405247
	Manual for 1260-X121	980914-X121
20 Pin Mating Connector	20 Pin Conn. Kit w/backshell & solder cup pins	407660
Additional Manual	Manual for 1260-X121	980914-X121

This page was intentionally left blank.

## Chapter 2

# INSTALLATION INSTRUCTIONS

---

### Unpacking and Inspection

1. Before unpacking the switching module, check the exterior of the shipping carton for any signs of damage. All irregularities should be noted on the shipping bill and reported.
2. Remove the instrument from its carton, preserving the factory packaging as much as possible.
3. Inspect the switching module for any defects or damage. Immediately notify the carrier if any damage is apparent.
4. Have a qualified person check the instrument for safety before use.

### Reshipment Instructions

1. Use the original packing material when returning the switching module to Racal Instruments for servicing. The original shipping carton and the instrument's plastic foam will provide the necessary support for safe reshipment.
2. If the original packing material is unavailable, wrap the switching module in an ESD Shielding bag and use plastic spray foam to surround and protect the instrument.
3. Reship in either the original or a new shipping carton.

### Installation

Installation of the 1260-X121 Switching Module into a 1260-100X Carrier assembly is described in the Installation section of the 1260-100X Adapt-a-Switch Carrier Manual.

## Module Configuration

The 1260-X121 is a 20-channel single-wire switch module consisting of twenty SPST relay switches ten SPST configuration relays. This architecture permits the 1260-X121 module to be organized via software as twenty SPST or ten 1X2 switches.

For a block diagram of the 1260-X121, see **Figure 2-1**.

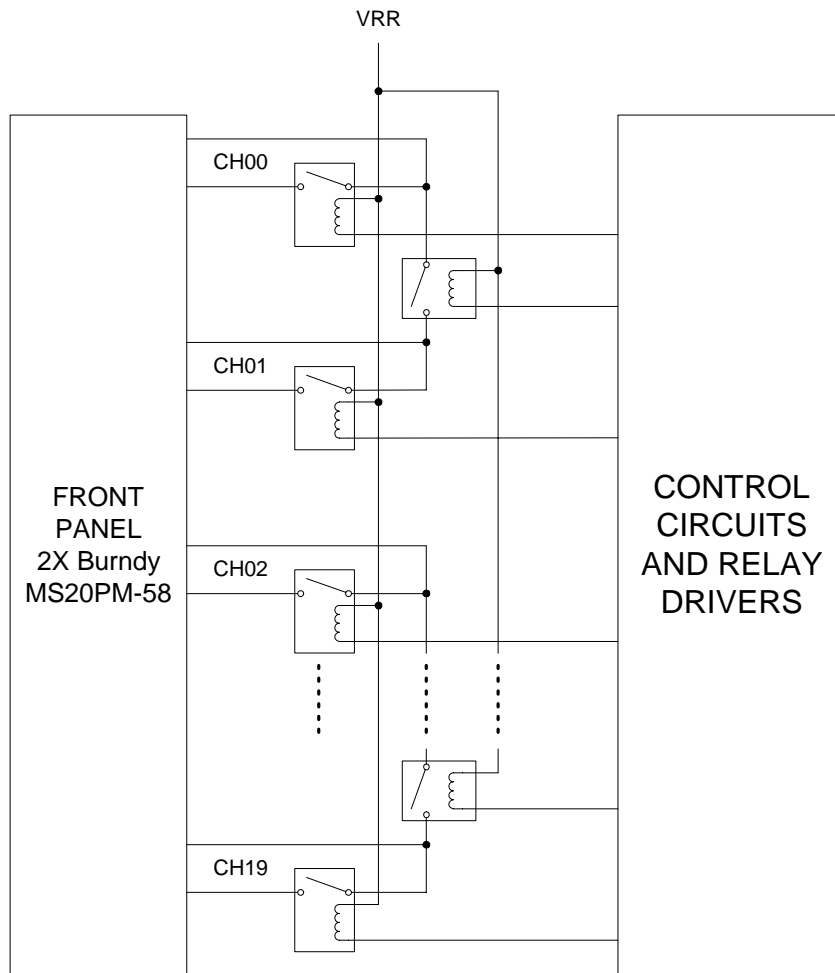

**Figure 2-1, 1260-X121 Block Diagram**



## Front Panel Connectors

The 1260-X121 has two 20-pin front-panel connectors, labeled J200 and J201. It has one pin for each input and one for each output. See **Figure 2-2** for pin numbering. **Table 2-1** shows the mapping of channel numbers to connector pins. Information about available mating connectors is provided immediately after **Table 2-1**.

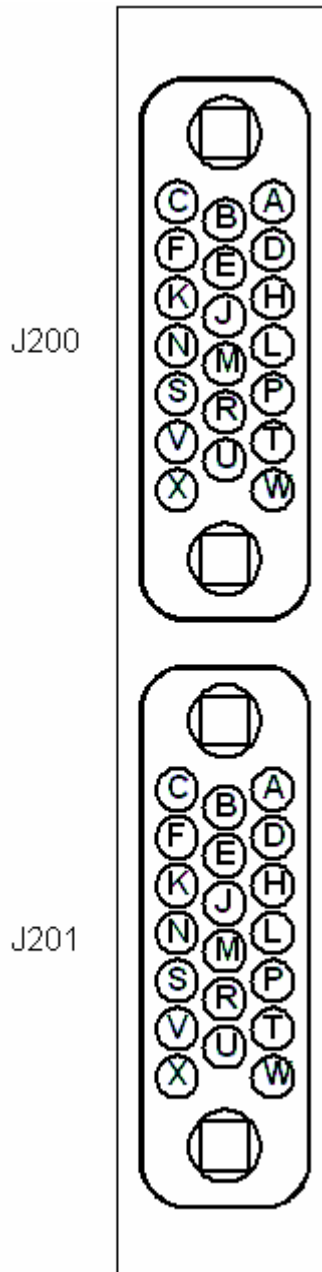



















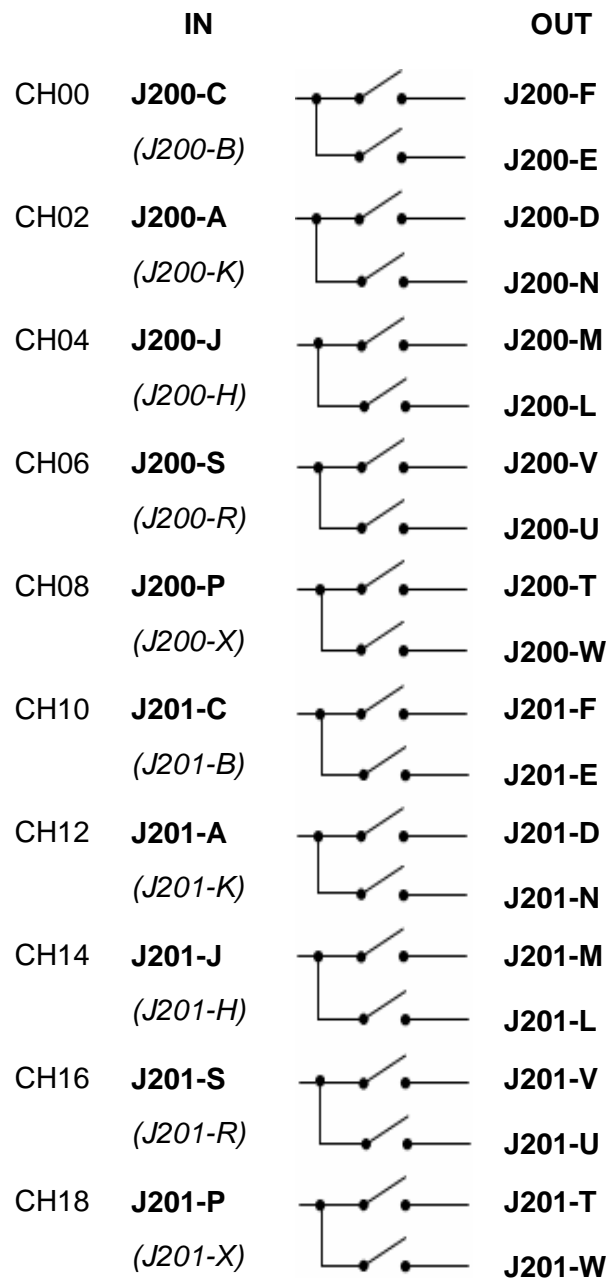

Figure 2-2, Front Panel Connector Pin Numbering

Table 2-1, 1260-X121 Front-Panel Connections

	IN		OUT
CH00	J200-C		J200-F
CH01	J200-B		J200-E
CH02	J200-A		J200-D
CH03	J200-K		J200-N
CH04	J200-J		J200-M
CH05	J200-H		J200-L
CH06	J200-S		J200-V
CH07	J200-R		J200-U
CH08	J200-P		J200-T
CH09	J200-X		J200-W
CH10	J201-C		J201-F
CH11	J201-B		J201-E
CH12	J201-A		J201-D
CH13	J201-K		J201-N
CH14	J201-J		J201-M
CH15	J201-H		J201-L
CH16	J201-S		J201-V
CH17	J201-R		J201-U
CH18	J201-P		J201-T
CH19	J201-X		J201-W

1260-X121 as (1x1)'s



1260-X121 as (1x2)'s

---

*Note*

Pins shown in parentheses are for reference only.

---

## Mating Connectors

Mating connector accessories are available for the 1260-X121:

20 Pin Connector Kit with backshell and pins  
P/N 407660

The 20-pin connector kit consists of a connector housing, aluminum backshell, and twenty solder-cup pins. The pins are also available from Positronic in crimp versions and for smaller wire diameters.

The mating connector pins are solder type. The corresponding removal tool is Racal P/N 9081.

After wire attachment, the pin is inserted in the housing and will snap into place, providing positive retention. To ensure that the pin is locked into place, the assembler should pull on the wire after insertion.

**Table 2-2, Mating Connectors and Pins**

Racal P/N	Manufacturer	Mfr. P/N	Description
602349-120	Positronic	GMCT20F0E100J0	Insulator block (diallyl pthalate), 20-position. Mates with front-panel connector. Pins sold separately.
601850-900	Positronic	FC114N2	Female contact, crimp type, for 14 AWG wire. Mates with front-panel connector pins.
None	Positronic	FC116N2	Female contact, crimp type, for 16 AWG wire. Mates with front-panel connector pins.
None	Positronic	FS114N2	Female contact, solder type, for 14 AWG wire. Mates with front-panel connector pins.
None	Positronic	FS116N2	Female contact, solder type, for 16 AWG wire. Mates with front-panel connector pins.

---

## More About Maximum Current Ratings

The front panel connector and pins are rated for 10A DC per pin, with all channels conducting full-rated current. This keeps the temperature rise within 10°C. It should be noted that with all electromechanical relays, the higher the switched power (voltage times current), the shorter the useful life of the relays.

Definitions:

- *Max current carrying capacity*

The maximum current that the relay can conduct if the relay is not switched while voltage is applied. The maximum current carrying capacity is affected by the size of the conducting section of the contact at its smallest area. The listed values are obtained from several tests in laboratories under room-temperature conditions (21°C). The contact is considered to be in free air. The maximum current carrying for the 1260-X121 is 10 A.

- *Max operating current*

The current the contacts can switch while conducting, without deteriorating. This depends on working conditions, such as dissipated heat, cooling provisions, ambient temperature, insulation material, etc. The maximum operating current for the 1260-X121 is 10 A.

- *Recommended continuous current*

The maximum current recommended for indefinitely-long time periods. The primary concern here is the heat generated in the relay. This specification can be applied for normal working conditions. The specification includes a safety margin. However, there are restrictions in the application of the given values. The most important restriction is the cross-sectional area of the connecting wire, insulation temperature range, and wire bundling. The recommended continuous current for the 1260-X121 is 10 A.

## Installation

To install the 1260-X121 Switching Module into a 1260-100X Carrier, engage the printed circuit board into the grooves of the desired carrier slot. Slide the 1260-X121 into the carrier until its connector mates with the connector on the carrier backplane. Push firmly to fully seat the connector. Tighten the two retaining screws at the top and bottom of the 1260-X121 plug-in.

## Chapter 3

# MODULE OPERATION

---

### Operating Modes

The 1260-X121 may be operated either in *message-based* mode or in *register-based* mode.

In the *message-based* mode, the 1260-01T switch controller interprets commands sent by the slot 0 controller, and determines the appropriate data to send to the control registers of the 1260-X121 module.

### Operating In Message-Based Mode

---

#### Channel Descriptors For The 1260-121

The standard 1260-01T commands are used to operate the 1260-X121 module. These commands are described in the 1260-01T User's Manual.

Each 1260-01T relay command uses a *channel descriptor* to select the channel(s) of interest. The syntax for a channel descriptor is the same for all 1260 series modules. In general, the following syntax is used to select a single channel:

```
(@ <module address> ( <channel> ) )
```

Where:

- <module address> is the address of the 1260-X121 module. This is a number in the range from 1 through 12, inclusive.
- <channel> is the 1260-X121 channel to operate. This is a number in the range from 0 through 19, inclusive.

Multiple individual channels may be specified using the following channel descriptor syntax:

```
@ <module address> ( <chan1> , <chan2>  
 , . . . , <chanN> ) )
```

A range of channels may be specified using the following channel descriptor syntax:

```
@ <module address> ( <first channel> :
<last channel> ) )
```

The following examples illustrate the use of the channel descriptors for the 1260-X121:

OPEN (@8(0))	Open channel 0 on the 1260-X121 that has module address 8.
CLOSE (@8(0,7))	Close channels 0 and 7 on the 1260-X121 that has module address 8.
CLOSE (@2(7:11))	Close channels 7 through 11 inclusive on the 1260-X121 that has module address 2.

## Reply To The MOD:LIST? Command

The chassis containing the 1260-X121 returns a reply to the MOD:LIST? command. This reply is unique for each different 1260 series switch module. The syntax for the reply is:

```
<module address> : <module-specific identification string>
```

For the 1260-X121 module the string value is:

```
1260-X121 20-CHANNEL SPST 10A SWITCH
```

Thus, for a 1260-X121 whose module address is 2, the reply to this query would be:

```
2 : 1260-X121 20-CHANNEL SPST 10A SWITCH
```



## Operating in Register-Based Mode

The 1260-X121 offers register-based mode when installed in VXI platforms that support it. In register-based mode, the 1260-X121 is operated by directly writing and reading to/from ports controlling up to eight relays each. To access the registers the following details must be assembled to generate an absolute address that can be wrote or read from:

The port and control registers are located in the VXIbus A24 Address Space. The A24 address for a port or control register depends on:

1. The A24 Address Offset assigned to the 1260-01T module by the Resource Manager program. The Resource Manager program is provided by the VXIbus slot-0 controller vendor. The A24 Address Offset is placed into the "Offset Register" of the 1260-01T by the Resource Manager.
2. The <module address> of the 1260-X121 module. This is a value in the range from 1 and 12 inclusive.
3. The 1260-X121 control register to be written to or read from. Each register on the 1260-X121 has a unique offset from the base address.

The base A24 address for the 1260-X121 module may be calculated by:

$$(A24 \text{ Offset of the } 1260-01T) + (1024 \times \text{Module Address of } 1260-121).$$

The A24 address offset is usually expressed in hexadecimal. A typical value of  $204000_{16}$  is used in the examples that follow.

A 1260-X121 with a module address of 7 would have the base A24 address computed as follows:

$$\begin{aligned} \text{Base A24 Address of } 1260\text{-X121} &= 204000_{16} + (400_{16} \times 7_{10}) \\ &= 205C00_{16} \end{aligned}$$

The port and control registers for Adapt-a-Switch plug-ins and conventional 1260-Series modules are always on odd-numbered A24 addresses. For port registers, the 1260-X121 reads and writes to the same location. For control registers, the 1260-X121 writes to one location, but reads back from another. **Table 3-1 and 3-5** provides offsets relative to the base address of the module for all port and control registers of the 1260-121. To obtain the absolute address where data is to be written or read from, the base address is added to the offset:

$$(\text{Base A24 } 1260\text{-X121 Address}) + \text{offset} = \text{absolute}$$

address

So, for our example base A24 address computed earlier, the following absolute addresses would apply for the operations indicated:

205C01      Port A read or written at this location  
 205E01      ID register read at this location

Before explaining the particulars of reading and writing to port and control registers, it is necessary to understand how the registers interact with the 1260-X121 relays. **Table 3-2 through 3-5** provides a detailed explanation of each register and how it interacts with the 1260-X121 module.

**Table 3-1, Register Offset Addresses of the 1260-X121 Module**

Register Name	Register Offsets to Add to Base Module Address	
	Write Location (hexadecimal)	Read Location (hexadecimal)
0	0x01	0x01
1	0x03	0x03
2	0x05	0x05
3	0x07	0x07
ID	Read Only	0x201
EPROM Descriptor	Read Only	0x203

**Table 3-2, ID Register Functionality of the 1260-X121 Module**

Register Table		ID Register
Module Version	Bit	Functionality Description
All	0	Always Reads 0x00 (Read Only)
	1	
	2	
	3	
	4	
	5	
	6	
	7	

Table 3-3, Register0 Functionality of the 1260-X121 Module

Register Table		Register 0	
Module Version	Bit	Functionality Description	
All	0	Relay 00	(0: relay open 1: relay closed)
	1	Relay 01	(0: relay open 1: relay closed)
	2	Relay 02	(0: relay open 1: relay closed)
	3	Relay 03	(0: relay open 1: relay closed)
	4	Relay 04	(0: relay open 1: relay closed)
	5	Relay 05	(0: relay open 1: relay closed)
	6	Relay 06	(0: relay open 1: relay closed)
	7	Relay 07	(0: relay open 1: relay closed)

Table 3-4, Register1 Functionality of the 1260-X121 Module

Register Table		Register 1	
Module Version	Bit	Functionality Description	
All	0	Relay 08	(0: relay open 1: relay closed)
	1	Relay 09	(0: relay open 1: relay closed)
	2	Relay 10	(0: relay open 1: relay closed)
	3	Relay 11	(0: relay open 1: relay closed)
	4	Relay 12	(0: relay open 1: relay closed)
	5	Relay 13	(0: relay open 1: relay closed)
	6	Relay 14	(0: relay open 1: relay closed)
	7	Relay 15	(0: relay open 1: relay closed)

Table 3-5, Register2 Functionality of the 1260-X121 Module

Register Table		Register 2		
Module Version	Bit	Functionality Description		
All	0	Relay 16	(0: relay open 1: relay closed)	
	1	Relay 17	(0: relay open 1: relay closed)	
	2	Relay 18	(0: relay open 1: relay closed)	
	3	Relay 19	(0: relay open 1: relay closed)	
	4	Relay 20 (Connect J200-C and J200-B)	(0: relay open	1: relay closed)
	5	Relay 21 (Connect J200-A and J200-K)	(0: relay open	1: relay closed)
	6	Relay 22 (Connect J200-J and J200-H)	(0: relay open	1: relay closed)
	7	Relay 23 (Connect J200-S and J200-R)	(0: relay open	1: relay closed)

Table 3-6, Register3 Functionality of the 1260-X121 Module

Register Table		Register 3	
Module Version	Bit	Functionality Description	
All	0	Relay 24 (Connect J200-P and J200-X)	(0: relay open 1: relay closed)
	1	Relay 25 (Connect J201-C and J201-B)	(0: relay open 1: relay closed)
	2	Relay 26 (Connect J201-A and J201-K)	(0: relay open 1: relay closed)
	3	Relay 27 (Connect J201-J and J201-H)	(0: relay open 1: relay closed)
	4	Relay 28 (Connect J201-S and J201-R)	(0: relay open 1: relay closed)
	5	Relay 29 (Connect J201-P and J201-X)	(0: relay open 1: relay closed)
	6	Not Used	
	7	Not Used	

Note:

Open: Indicates C not connected to NO contact

Closed: Indicates C connected to NO contact

Table 3-7, EPROM Descriptor Functionality of the 1260-X121 Module

Register Table		EPROM Descriptor Register	
Module Version	Bit	Functionality Description	
All	0	Each time this register is read, it advances a memory pointer to the next memory location in the on-board EPROM. To reset this pointer to the beginning, read the ID register. This resets the memory pointer. The descriptor register contains a long string of data, typically used by the Adapt-a-Switch carrier for configuration purposes. Additionally, this data contains the card identification string for the specific type of card (i.e. 1260-121). These identification strings are located at EPROM memory locations 0x23 through 0x34.	
	1		
	2		
	3		
	4		
	5		
	6		
	7		

Writing to a port location is a straightforward process. Setting a bit high in a port register causes the corresponding relay channel to close.

It is especially important to realize that a single write operation controls eight separate control lines or output devices simultaneously. Therefore if only a single bit change is desired, the following process must be observed.

1. Read the register, inverting the bit pattern.
2. Mask the appropriate bit with an 'AND' operation and a byte mask with all undesired bits set to a '1' and the desired bit set to a '0' or '1' depending on whether the bit is to be set or cleared in the desired register.
3. Write the masked data back into the register.

As simple as this may seem, a number of products reported as faulty and sent back for repair are typically the result of inappropriate register accesses.

Because of the 1260-X121 relay driver architecture, registers A and B will read back inverted from what was written to them.

The VISA I/O library may be used to control the module. The VISA function `viOut8()` is used to write a single 8-bit byte to a control register, while `viIn8()` is used to read a single 8-bit byte from the control register. The following code example shows the use of `viOut8()` to update the 1260-X121 module.

This page was left intentionally blank.

## Chapter 4

# PRODUCT SUPPORT

---

### **Product Support**

Racal Instruments has a complete Service and Parts Department. If you need technical assistance or should it be necessary to return your product for repair or calibration, call 1-800-722-3262. If parts are required to repair the product at your facility, call 1-949-859-8999 and ask for the Parts Department.

When sending your instrument in for repair, complete the form in the back of this manual.

For worldwide support and the office closes to your facility, refer to the Support Offices section on the following page.

### **Reshipment Instructions**

Use the original packing material when returning the 1260-X121 to Racal Instruments for calibration or servicing. The original shipping container and associated packaging material will provide the necessary protection for safe reshipment.

If the original packing material is unavailable, contact Racal Instruments Customer Service for information.

## Support Offices

### RACAL INSTRUMENTS

#### United States

(Corporate Headquarters and Service Center)  
4 Goodyear Street, Irvine, CA 92618  
Tel: (800) 722-2528, (949) 859-8999; Fax: (949) 859-7139

5730 Northwest Parkway Suite 700, San Antonio, TX 78249  
Tel: (210) 699-6799; Fax: (210) 699-8857

#### Europe

(European Headquarters and Service Center)  
18 Avenue Dutartre, 78150 LeChesnay, France  
Tel: +33 (0)1 39 23 22 22; Fax: +33 (0)1 39 23 22 25

29-31 Cobham Road, Wimborne, Dorset BH21 7PF, United Kingdom  
Tel: +44 (0) 1202 872800; Fax: +44 (0) 1202 870810

Via Milazzo 25, 20092 Cinisello B, Milan, Italy  
Tel: +39 (0)2 6123 901; Fax: +39 (0)2 6129 3606

Racal Instruments Group Limited, Technologie Park,  
D-51429 Bergisch Gladbach, Germany  
Tel: +49 2204 844205; Fax: +49 2204 844219



## Repair and Calibration Request Form

To allow us to better understand your repair requests, we suggest you use the following outline when calling and include a copy with your instrument to be sent to the Racal Repair Facility.

Model \_\_\_\_\_ Serial No. \_\_\_\_\_ Date \_\_\_\_\_

Company Name \_\_\_\_\_ Purchase Order # \_\_\_\_\_

Billing Address \_\_\_\_\_  
City \_\_\_\_\_

State/Province \_\_\_\_\_ Zip/Postal Code \_\_\_\_\_ Country \_\_\_\_\_

Shipping Address \_\_\_\_\_  
City \_\_\_\_\_

State/Province \_\_\_\_\_ Zip/Postal Code \_\_\_\_\_ Country \_\_\_\_\_

Technical Contact \_\_\_\_\_ Phone Number ( ) \_\_\_\_\_

Purchasing Contact \_\_\_\_\_ Phone Number ( ) \_\_\_\_\_

1. Describe, in detail, the problem and symptoms you are having. Please include all set up details, such as input/output levels, frequencies, waveform details, etc.

---

---

---

---

2. If problem is occurring when unit is in remote, please list the program strings used and the controller type.

---

---

---

3. Please give any additional information you feel would be beneficial in facilitating a faster repair time (i.e., modifications, etc.)

---

---

---

4. Is calibration data required?      Yes    No    (please circle one)

Call before shipping                      Ship instruments to nearest support office.

Note: We do not accept  
"collect" shipments.